

MB6F THRU MB10F

SINGLE-PHASE 0.8AMPS.GLASS PASSIVATED BRIDGE RECTIFIERS

FEATURES

- . High surge current capability
- . Ideal for printed circuit board
- . Good for printed circuit board
- . Glass passivated junctions
- . Reliable low cost construction utilizing molded plastic technique
- . Small size , simple installation
- . High temperature soldering guaranteed:
260°C/10 seconds at terminals.

MECHANICAL DATA

- . Case: Molded plastic
- . Epoxy: UL 94V-0 rate flame retardant
- . Lead: MIL-STD- 202E, Method 208 guaranteed
- . Polarity: Symbols molded or marked on body
- . Mounting position: Any

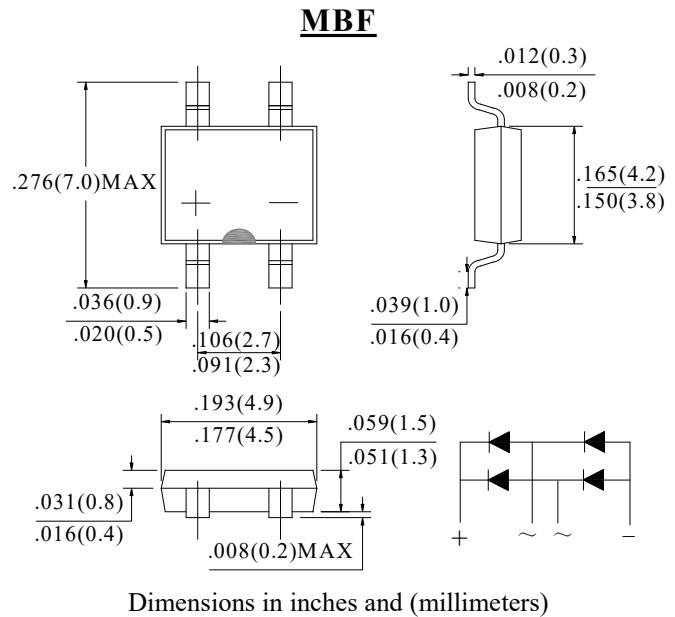

MAXIMUM RATINGS AND ELECTRICAL CHARACTERISTICS

Ratings at 25°C ambient temperature unless otherwise specified.

Single phase, half wave, 60Hz, resistive or inductive load. For capacitive load, derate current by 20%

Type Number	SYM BOL	MB6F	MB8F	MB10F	units
Maximum Recurrent Peak Reverse Voltage	V_{RRM}	600	800	1000	V
Maximum RMS Voltage	V_{RMS}	420	560	700	V
Maximum DC blocking Voltage	V_{DC}	600	800	1000	V
Average Forward Rectified Current	$I_{F(AV)}$	1.0			A
Peak Forward Surge Current 8.3ms single half sine-wave superimposed on rate load (JEDEC method)	I_{FSM}	30			A
Maximum Forward Voltage Drop per element at 0.4A DC	V_F	0.95			V
Maximum DC Reverse Current @ $T_J=25^\circ\text{C}$ at rated DC blocking voltage @ $T_J=125^\circ\text{C}$	I_R	5.0 200.0			μA
I^2t Rating for Fusing ($t < 8.3\text{ms}$)	I^2t	3.74			A^2Sec
Typical Junction Capacitance Per Leg(Note1)	C_J	10			pF
Typical Thermal Resistance Per Leg(Note2)	$R_{(JA)}$	85			$^\circ\text{C}/\text{W}$
Storage Temperature	T_{STG}	-55 to +150			$^\circ\text{C}$
Operating Junction Temperature	T_J	-55 to +150			$^\circ\text{C}$

Note:

1. Measured at 1.0 MHz and applied reverse voltage of 4.0Vdc
2. Thermal Resistance from Junction to Ambient mounted on P.C.B with 0.2×0.2" (5×5mm) copper pads

RATING AND CHARACTERISTIC CURVES

FIG.1-TYPICAL FORWARD CURRENT DERATING CURVE

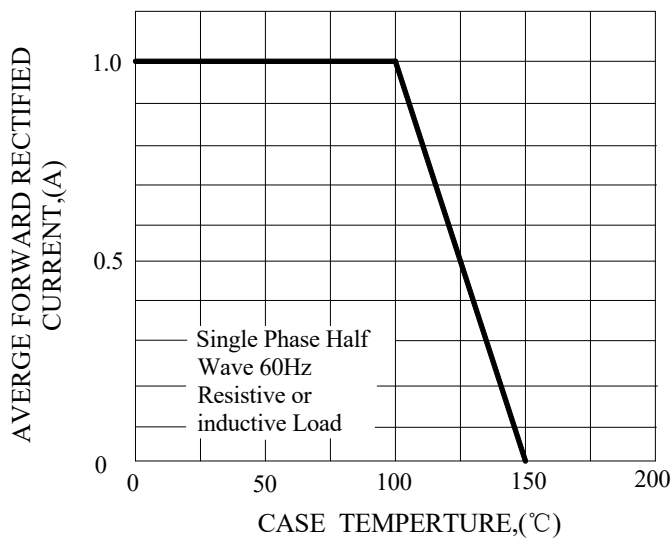

FIG.2-TYPICAL INSTANTANEOUS FORWARD CHARACTERISTICS

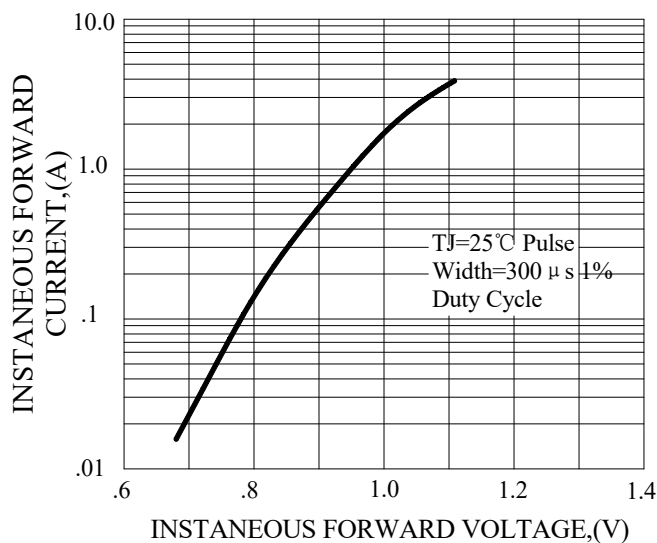

FIG.3-MAXIMUM NON-REPETITIVE FORWARD SURGE CURRENT

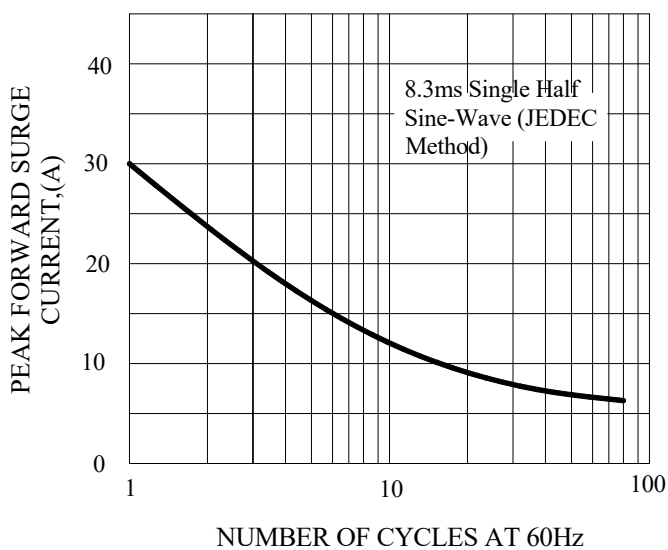
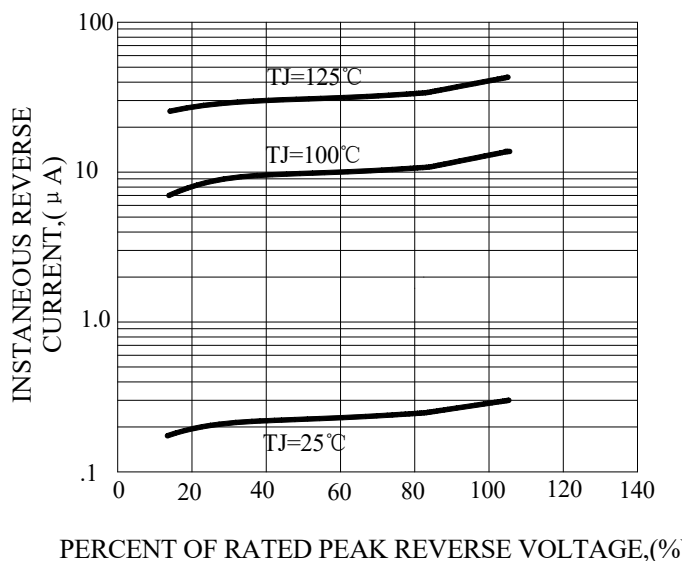
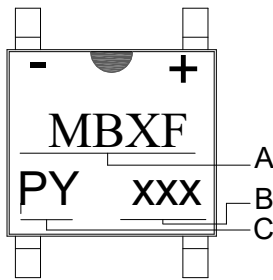

FIG.4-TYPICAL REVERSE CHARACTERISTICS



Marking and packaging illustration

1、Marking



SYMBOL	Explanation
A	Product Name
B	Date Code
C	Trademark

2、Packaging

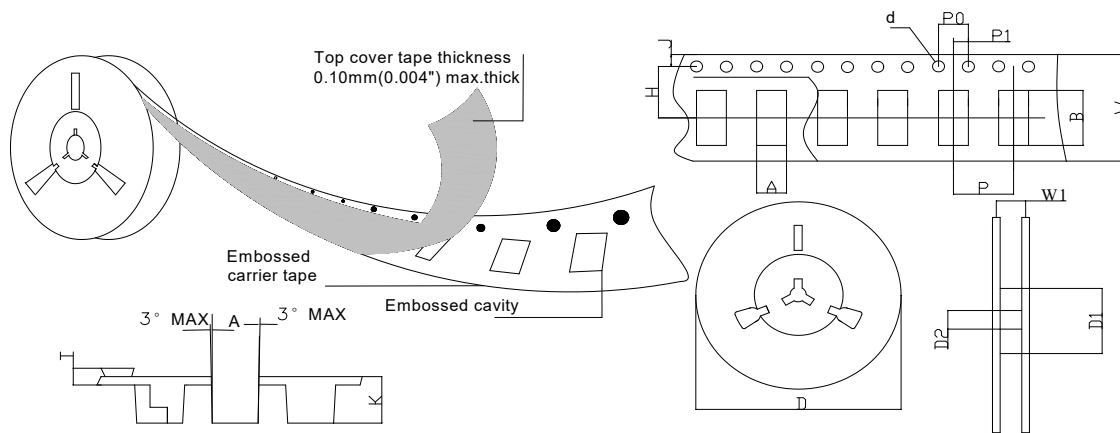

SPECIFICATIONS mm(inch)		PACKAGE	SPECIFICATIONS mm(inch)		PACKAGE
ITEM	SYM BOL	MBF	ITEM	SYM BOL	MBF
Carrier width	A	5.15(0.203)Max	Carrier depth	K	2.88(0.113)Typ
Carrier length	B	7.25(0.285)Max	Punch hole pitch	P	8.00(0.315)Typ
Sprocket hole	d	ø1.55(0.061)Typ	Sprocket hole pitch	P0	4.00(0.157)Typ
Reel outer diameter	D	330.0(13.0)Typ	Embossment center	P1	2.00(0.079)Typ
Reel inner diameter	D1	50.0(2.913)Min	Overall tape thickness	T	0.30(0.012)Typ
Feed hole diameter	D2	13.0(0.512)Typ	Tape width	W	12.0(0.472)Typ
Sprocket hole position	J	1.75(0.069)Typ	Reel width	W1	12.4(0.488)Min
Punch hole position	H	5.50(0.217)Typ			